

Complete Door Hardware Info Guide



































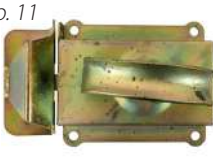

Hardware for Dutch Doors & Windows, Stall Doors, and Utility Doors

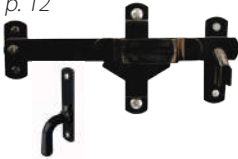

Complete Door Hardware

Product Overview

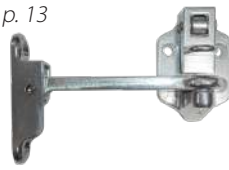
p. 3  16" Rockwood Hinge with 1" Set Back	p. 3  24" Rockwood Hinge	p. 3  Rockwood Strap Hinge	p. 4  Decorative Rockwood Back Plate	p. 4  16" Adjustable Rockwood Hinge	p. 4  Adjustable Rockwood Double Strap Hinge
p. 5  24" Adjustable Madison Strap Hinge	p. 5  24" Adjustable Madison Double Strap Hinge	p. 5  24" Madison Decorative Back Plate	p. 6  10" Tee Hinge	p. 6  8" Tee Hinge	p. 6  12" x 2" Hinge
p. 7  Heavy-Duty Flush Pull Handle	p. 7  Flush Pull Handle	p. 7  Door Snugger	p. 8  Heavy-Duty Door Handle	p. 8  Heavy-Duty Galvanized Door Handle	p. 8  Heavy-Duty Black Door Handle
p. 8  Small Pull Handle	p. 9  Horseshoe Latch	p. 9  Horseshoe Catch	p. 9  Slide Latch	p. 9  Top Latch	p. 10  Spring Latch
p. 10  Thumb Latch	p. 10  Jamb Latch	p. 11  Heavy-Duty Door Latch	p. 11  Large Heavy-Duty Door Latch	p. 11  Small Heavy-Duty Door Latch	p. 11  Easy Door Latch
p. 12  Iron Grip Latch	p. 12  Flush Mount Latch	p. 12  Door Bottom Sweep	p. 13  Cane Bolt	p. 13  Spring Bolt with Chain	p. 13  Door Hold-Back

Complete Door Hardware

16" Rockwood Hinge with 1" Set Back



Description: Hinge 1" Set Back 16" Long Black

Part # 365-216S

Details:

- 2 1/2" wide x 16" long with a 6" x 3 1/8" mounting plate
- 16" strap hinge with a 1" offset back into the door opening
- Creates a very strong and unique look
- Available galvanized by special order

Fasteners:

- Door side: 3/8" Carriage Bolts/Lag Bolts (x4)
- Frame side: 1/4" Lag Bolts (x4)

24" Rockwood Hinge



Description: Hinge 24" Strap Black

Part # 365-224S (Special Order)

Details:

- 2 1/2" wide x 24" long with a 6" x 2 3/4" mounting plate
- Creates a very strong and unique look

Fasteners:

- Door side: 3/8" Carriage Bolts/Lag Bolts (x4)
- Frame side: 1/4" Lag Bolts (x4)

Rockwood Strap Hinge

The Rockwood Strap Hinge is one of our most popular hinges. This heavy-duty hinge comes standard with a black powder-coated finish and a heavy-duty stainless steel hinge pin and brass washers to allow for effortless movement. Heavy 3/16" materials provide a long life.



Description: Heavy Duty Strap 16" Hinge

Part # 365-216 (16"), 365-224 (24" - Special Order), 365-236 (36" - Special Order)

Details:

- Available galvanized by special order (allow 2-week lead time)

Fasteners:

- Door side: 3/8" Carriage Bolts (x4 for 16" and 24", x5 for 36")
- Frame side: 1/4" Lag Bolts (x4)

Complete Door Hardware

Decorative Rockwood Back Plate



The Rockwood Decorative Back Plate create a consistent look and feel when paired with either our Rockwood or Madison door hardware systems, but it can be added to the interior or exterior of any door for an elegant touch. The laser cut plate lines up with the hinge holes so a carriage bolt can be used to bolt directly through the door and create a very strong sandwich door system.

Description: (K) 16" Heavy Duty Rockwood Decorative Back Plate Black

Part # 365-216BP (16"), 365-224BP (24" - Special Order), 365-236BP (36" - Special Order)

Details:

- Available zinc-plated by special order

16" Adjustable Rockwood Hinge



Description: (K) 16" Heavy Duty Rockwood Adjustable Strap Hinge Black

Part # 365-216A

Details:

- Creates a very strong and unique look
- Stainless steel hardware

Fasteners:

- Door side: 3/8" Carriage Bolts/Lag Bolts (x4)
- Frame side: 1/4" Lag Bolts (x4)



Welded-on heavy-duty adjustable hinge system with CNC machined stainless steel hinge bolt with a Delron bushing pressed in (left). Adjust your door hinges at any time if there is movement.

Adjustable Rockwood Double Strap Hinge



Description: (K) 16" Heavy Duty Rockwood Adjustable Double Strap Hinge Black

Part # 365-216AD (16"), 365-224AD (24" - Special Order), 365-236AD (36" - Special Order)

Details:

- Creates a very strong and unique look
- Stainless steel hardware

Fasteners:

- Door side: 3/8" Carriage Bolts/Lag Bolts (x8)
- Frame side: 1/4" Lag Bolts (x8)

Complete Door Hardware

24" Adjustable Madison Strap Hinge

Description: (K) Heavy Duty Madison Adjustable Strap Hinge 24" Painted

Part # 365-224AM

Details:

- Stainless steel hardware

Fasteners:

- Door side: 5/16" Lag Bolts (x5)
- Frame side: 1/4" Lag Bolts (x6)



24" Adjustable Madison Double Strap Hinge

Description: (K) Heavy Duty Madison Adjustable Strap Hinge 24" Painted

Part # 365-224ADM

Details:

- Stainless steel hardware

Fasteners:

- Door side: 5/16" Lag Bolts (x10)
- Frame side: 1/4" Lag Bolts (x6)

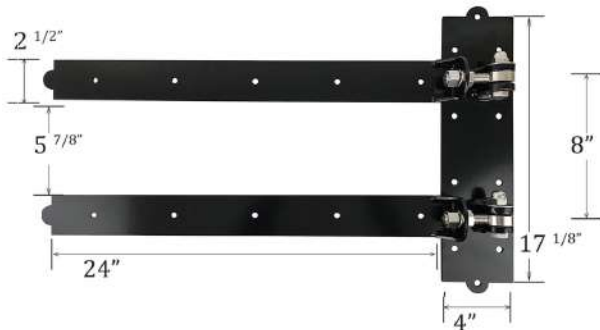

24" Madison Decorative Back Plate

The Madison Decorative Back Plate creates a highly sought-after rustic look and feel. Manufactured similarly to the hinges, it can be added to the interior or exterior of any door. Its laser-cut plate lines up with the hinge holes so that a carriage bolt can be used to bolt directly through the door and create a very strong sandwich door system. The Madison Decorative Back Plate is available to match both the Rockwood and Madison door hardware systems.

Description: (K) Madison Decorative Back Plate

Part # 365-224BPM

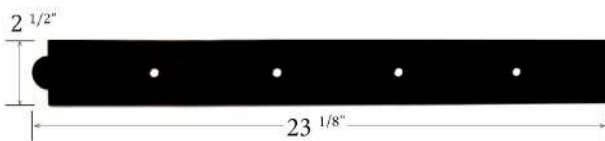

Complete Door Hardware

10" T-Hinge

Description: Hinge 10" Tee Galvanized

Part # 364-210T

Details:

- Heavy-duty construction
- Hot-dipped galvanized
- Removeable pin

Fasteners:

- Door side: #14 Screws/5/16" Lag Bolts (x4)
- Frame side: 5/16" Lag Bolts (x7)

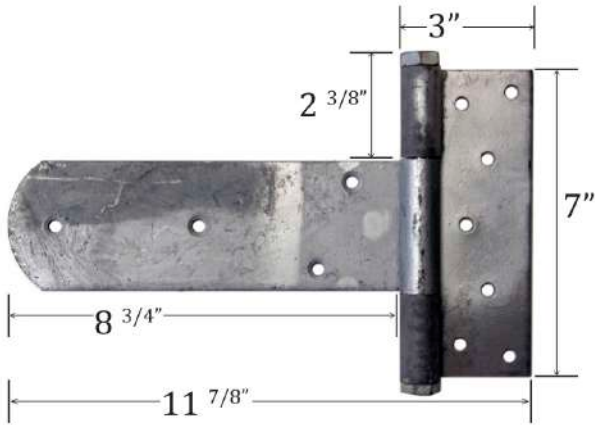

8" T-Hinge

Description: Hinge 8" Tee Galvanized, Hinge 8" Tee Black Painted

Part # 364-28T (Galvanized), 365-28T (Black)

Details:

- Heavy-duty construction
- Hot-dipped galvanized or black powder-coated
- Removeable pin

Fasteners:

- #14 Screws (x8)

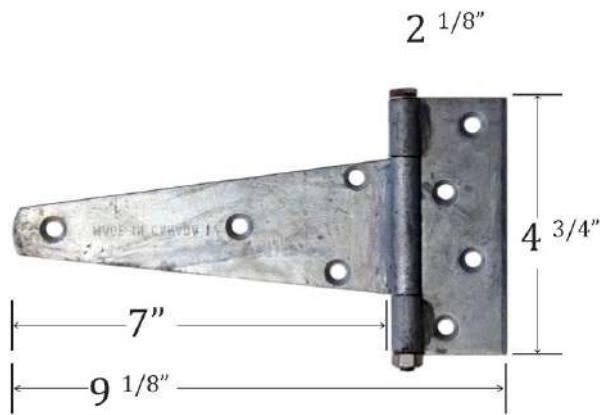

12" x 2" Hinge

Description: Hinge 12" x 2" Galv, Hinge 12" x 2" Black

Part # 364-212S (Galvanized), 365-212S (Black)

Details:

- Heavy-duty hinge for doors weighing up to 200lbs
- Galvanized or black powder-coated with stainless steel pin and brass washers
- 1/4" thick

Fasteners:

- Door side: 3/8" Carriage Bolts (x3)
- Frame side: 1/4" Lag Bolts (x3)

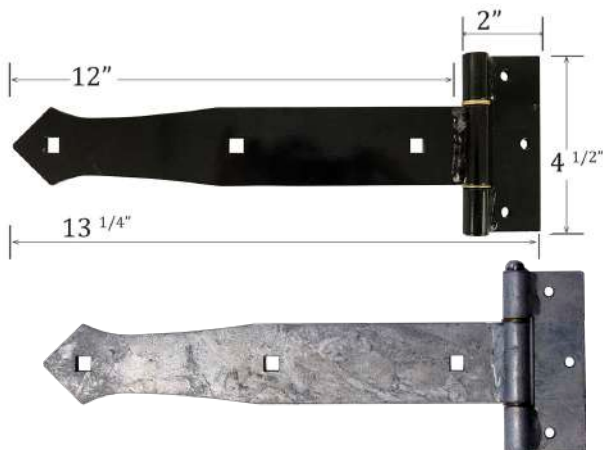

Complete Door Hardware



Heavy-Duty Flush Pull Handle

Description: Flush Pull Handle Heavy Duty (Black)

Part # 364-DLFPHD

Details:

- Helps open heavy doors
- Heavy-duty cast iron
- 5" x 6 3/8"



Flush Pull Handle

Description: Flush Pull Handle (Silver Finish)

Part # 364-DLFP

Details:

- Helps open heavy doors
- Galvanized
- 4 1/2" x 7"



Door Snagger

Description: Door Snagger

Part # 364-DLDS

Details:

- Used to keep sliding doors tightly closed
- Fits most sliding doors
- Easy to install
- Not accessible from outside
- Zinc-plated
- 1 1/2" x 14 1/2"

Complete Door Hardware



Heavy-Duty Door Handle

Description: (K) Door Handle Heavy Duty 9" x 1 1/2" Galvanized, (K) Door Handle Heavy Duty 9" x 1 1/2" Painted

Part # 364-DH9 (Galvanized), 365-DH9 (Painted)

Details:

- Excellent for large sliding doors
- Hot-dipped galvanized or black powder-coated
- 9" x 1 1/2"



Heavy-Duty Galvanized Door Handle

Description: Door Handle Galvanized

Part # 364-DH

Details:

- Affordable contoured handle
- Galvanized only
- 7 3/8" x 1 3/8"



Heavy-Duty Black Door Handle

Description: Door Handle - Black

Part # 365-DLBH

Details:

- Helps open heavy doors
- Galvanized
- 3 3/4" handle area x 6 1/4" overall length x 1 7/8" width



Small Pull Handle

Description: Door Handle Mini Zinc Coated (SO)

Part # 364-331

Details:

- For use on smaller doors such as utility cabinets and access doors
- Simple to install
- 5" total length; 3 1/4" handle length

Complete Door Hardware

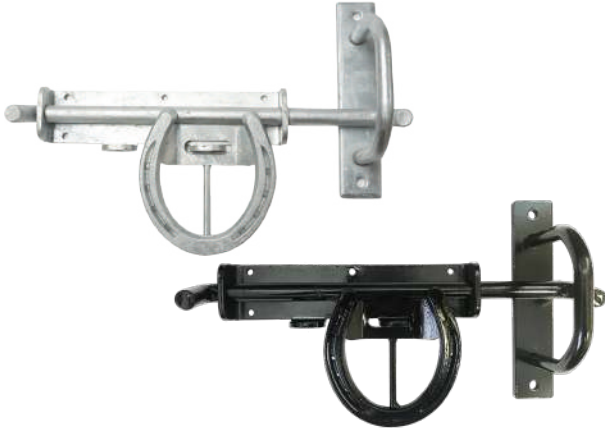

Locking Horseshoe Latch

Description: (K) Horseshoe Door Latch Locking, (K) Horseshoe Door Latch Locking Painted

Part # 364-HL (Galvanized), 365-HL (Black)

Details:

- Hot-dipped galvanized or black powder-coated
- 13 1/2" latch length
- 7 1/2" catch height x 1 1/2" catch width



Horseshoe Catch

Description: (K) Horseshoe Door Latch Locking Galv for Hinged Door, (K) Horseshoe Door Latch Locking Painted for Hinged Door

Part # 364-HLH (Galvanized), 365-HLH (Painted)

Details:

- For installation on a swinging door
- Hot-dipped galvanized or black powder-coated
- 5/8" steel catch



Slide Latch

Description: (K) Slide Latch Sliding Door, Slide Latch Economy Sliding

Part # 364-S (Kit), 364-SL

Details:

- Good choice for swinging or sliding doors that do not require the strength of our Horseshoe Latch
- Made of zinc-plated steel with zinc hardware
- Comes complete with everything to install on a wood door; special screws required for installation on a steel door (not included)

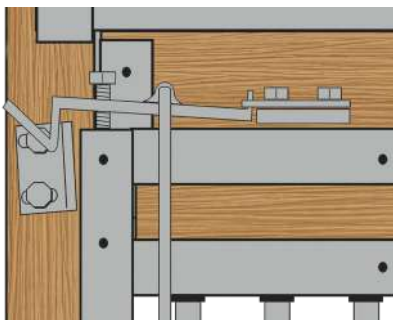

Top Latch

Description: (K) Door Latch w/Lifting Rod Kit Pro-Tek, (K) Door Latch w/Lifting Rod Kit Pro-Tek Painted

Part # 364-D (Galvanized), 365-D (Painted)

Details:

- For sliding stall doors

Complete Door Hardware



Spring Latch

Description: (K) Spring Latch 1/2" x 6" - Zinc Plated

Part # 364-SLZ

Details:

- For Dutch doors and windows or gates
- 1/2" width x 6" length



Thumb Latch

Description: Door Latch Thumb Latch

Part # 364-DLTL

Details:

- Handles are made of grey iron casting and are 7 3/4" long
- Thumb pieces are made of grey iron casting
- Bar is made of steel and is 1" x 1/4" x 9 1/4" long
- Zinc plated finish
- Fasteners included



Jamb Latch

Description: Jamb Latch

Part # 364250

Details:

- Used to secure sliding doors
- 7"

Complete Door Hardware

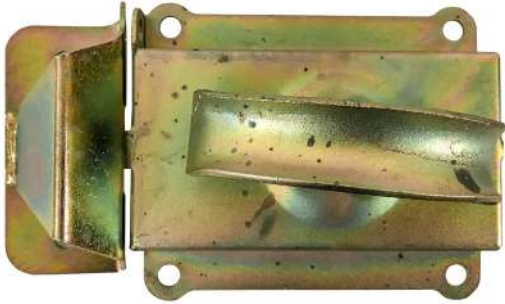

Heavy-Duty Door Latch

Description: Martins Door Latch Large Heavy Duty Zinc Plated

Part # 364-DLHD

Details:

- Great for barn and shed doors
- 6" x 5"
- Ionized



Large Heavy-Duty Drop Latch

Description: Heavy Duty Drop Latch Zinc Plated

Part # 364-DLHDZP

Details:

- Springloaded drop door latch
- For doors 2 1/4" to 3" thick
- Yellow zinc-plated



Small Heavy-Duty Door Latch

Description: Martins Door Latch Small Heavy Duty Stainless Steel

Part # 364-DLHDSS

Details:

- Stainless steel
- Great for barns or shed doors
- 5" length x 3 1/2" height



Easy Door Latch

Description: Door Latch Easy Latch

Part # 364-DLEL

Details:

- Yellow zinc-plated
- Adjustable for doors 1 1/8" to 2 1/4" thick

Complete Door Hardware

Iron Grip Latch

Description: (K) Iron Grip Latch Heavy Duty Latch with Cast Handle 2" to 5" Black

Part # 365-100

Details:

- Cast iron handle
- For swinging doors
- Reversible left/right use
- Iron grip on other side
- For doors 2" to 5" thick



Flush Mount Latch

Description: Flush Mount Latch Black

Part # 365-DL152

Details:

- Combination lock and latch
- Can be operated from either side of door
- For installation on sliding and swinging doors
- For doors up to 2 3/4" thick with 1 1/2" x 5/16" x 14" bar size
- Black enamel



Door Bottom Sweep

Description: Dutch Door Bottom Sweep 4ft

Part # 380-01

Details:

- For the bottom of Dutch doors
- Reduces dust, dirt, and elements from entering barn
- 1" bristle



Complete Door Hardware



Cane Bolt

Description: (K) Cane Bolt 1/2" x 12", (K) Cane Bolt 3/4" x 24"

Part # 364-DLCB (1/2" x 12"), 364-DLCB24 (3/4" x 24")

Details:

- Used to hold the bottom of a door in place when two doors meet and only one is used at a time
- Can also be used to secure one side of a double gate; once the first gate is secured, the second gate can be latched to the first with a gate latch
- Formed bar steel with holding brackets



Spring Bolt with Chain

Description: Spring Bolt with Chain

Part # 364-DLSB

Details:

- Housing is 5 1/2" high x 2 7/8" wide with a beveled bolt
- Self closing for the top of a Dutch or double Dutch door
- Fasteners included
- Zinc-plated

Door Hold-Back

Description: Dutch Door 490 Cast Aluminum Door Holder

Part # 02-DDDH

Details:

- Cast aluminum
- Holds open Dutch doors or windows
- 4" length

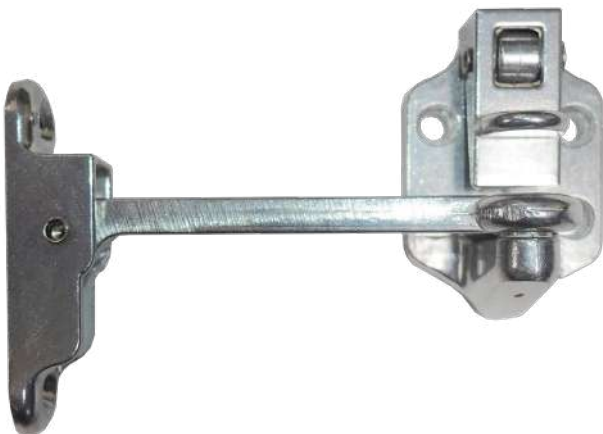

Complete Door Hardware

Sliding Door Hardware

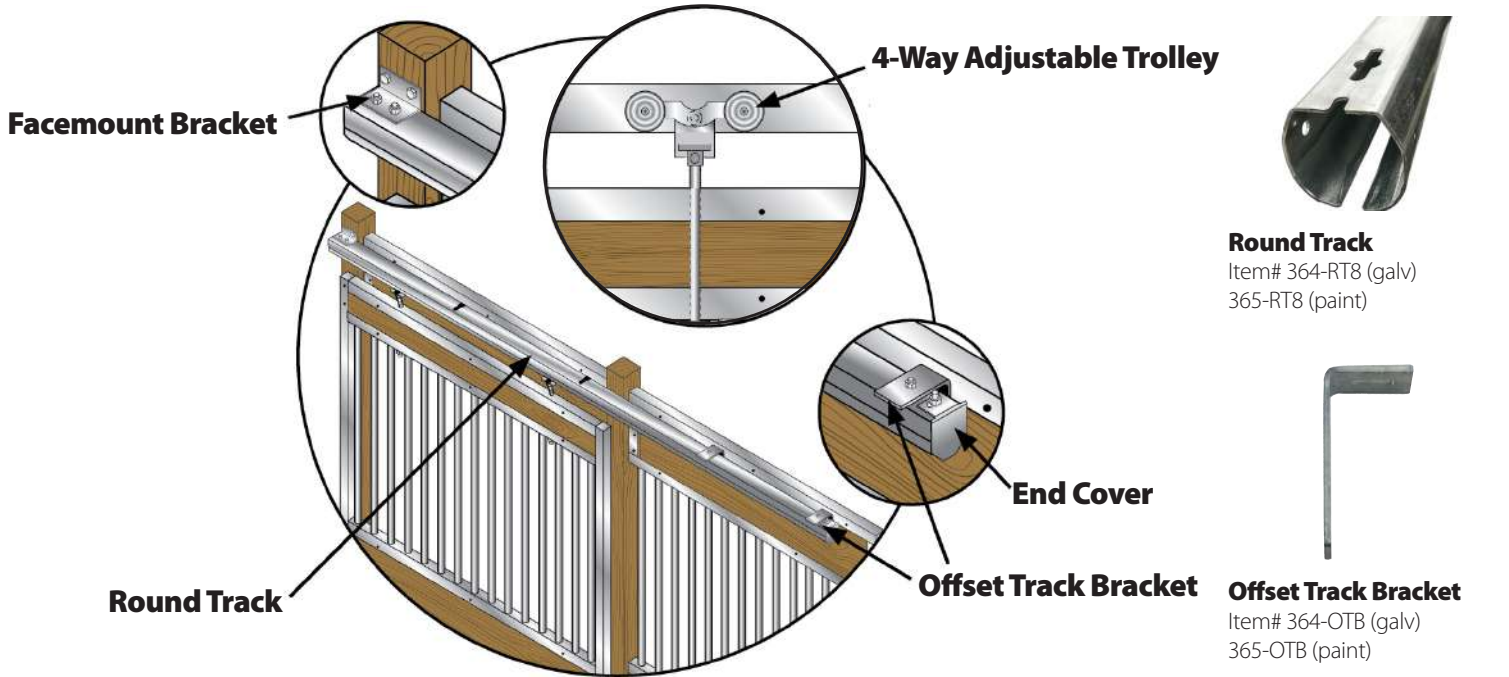

Round Track
Item# 364-RT8 (galv)
365-RT8 (paint)



Offset Track Bracket
Item# 364-OTB (galv)
365-OTB (paint)



4-Way Adjustable Round Track Trolley
Item# 364-RTT28T9



Round Track 90° Door Hanger Trolley
Item# 364-RT90



End Cover
Item# 364-RTEC (galv)
365-RTEC (paint)



Splice Collar
Item# 364-RTSC (galv)
365-RTSC (paint)



Facemount Bracket
Item# 364-RTFB (galv)
365-RTFB (paint)



Wall Bumper
Item# 364-WB (galv)
365-WB (paint)



Stay Roller
Item# 364-SR



Adjustable Stay Roller
Item# 364-SRA



Post Bumper
Item# 364-PB (galv)
365-PB (paint)



Rubber Stay Guide
Item# 365-402 (for welded doors), 365-400 (for designer doors using 2" door tube)

Stall Accessories



U-Channels
Used to support wall boards between posts



Wall Braces
Used to brace long-spanning wall boards 8' and over



Wall Capping
Used to help protect tops from damage and to prevent chewing



Post Edging
Used to help protect posts from damage and to prevent chewing